

Poids = 1350 kg/pce

Douille de levage : 2 M 24

Béton HSR L.A.

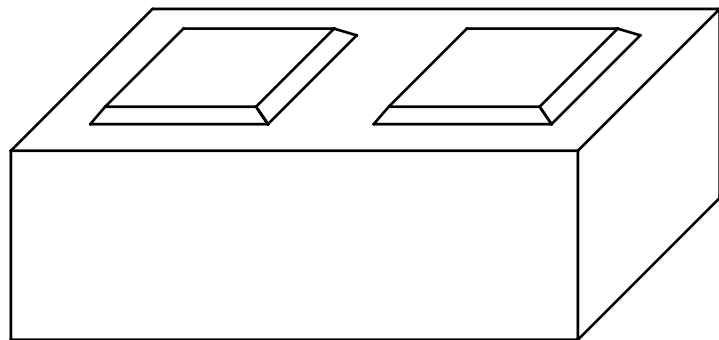

Vue en plan

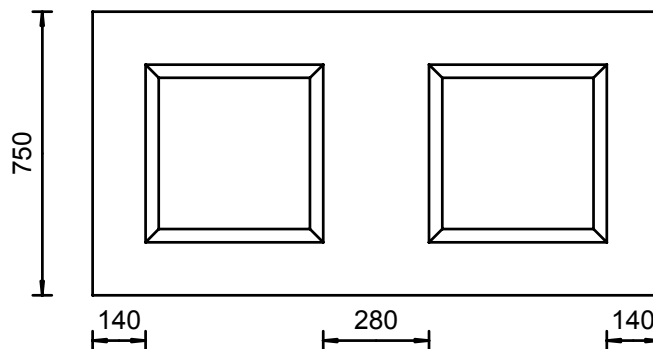

Vue de face

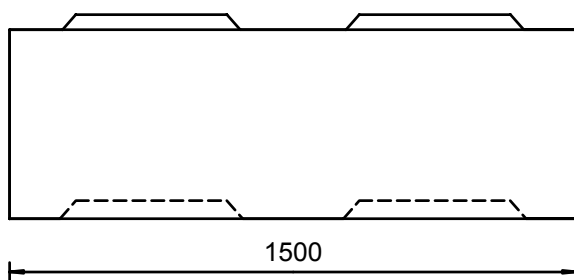

Vue de côté

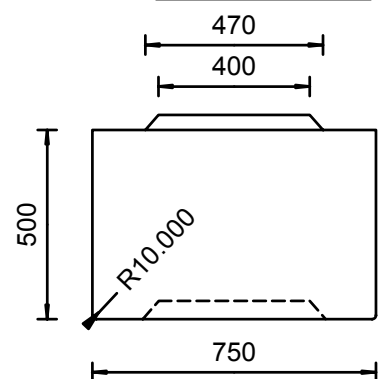

Coupe centrale

